



FIRE, DRAUGHT, WEATHER & ACOUSTIC SEALS

Tel: 01329 221111 Fax: 01329 221122
 Web: www.wis-ltd.com Email: sales@wis-ltd.com

ROUTER CUTTERS

Door & Window Seal Groovers

A range of cutters for grooving doors and frames to accept door and window seals. The cutters are bearing guided and fitted with dust shields; the design of the cutter allows the groove to be positioned against the bottom of the rebate if required. The cutter is supplied with 1/2" shank and bearing to provide a rebate depth 'G' of 3mm as standard. [other shank (C) and bearing sizes available].

The T5812 door cutter is suitable for Aquamac 21, Techfoam 1110 & Exitex CPX/A10 seals and the T5820 cutter suits Aquamac 63 and Techfoam 6565 seals.

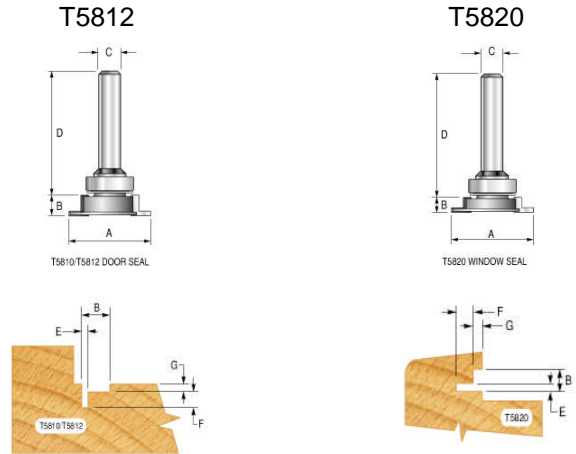

Ref No.	A	B	C	D	E	F
T5812 - 1/2"	46mm	10.8mm	1/2"	82mm	2.8mm	6mm
T5820 - 1/2"	46mm	7.5mm	1/2"	82mm	2.7mm	6mm

Weatherseal Groovers

The T5883 Compact Groover has a small overall diameter making it suitable for use in small hand routers, it can be used for in-situ grooving and cuts into internal corners leaving a minimum radius to be cleaned by hand. The design of the cutter allows the groove to be positioned against the bottom of the rebate if required. The cutter is supplied with 1/4" shank and bearing to provide a rebate depth 'E' of 6mm as standard. [other cutter (B), shank (C) and bearing sizes available].

The T5850 Weatherseal Groover will produce a 2.8mm wide groove that will suit many types of sealing strip which require a 3mm nominal groove. The design of the cutter allows the groove to be positioned against the bottom of the rebate if required. The cutter is supplied with 1/2" shank and bearing to provide a rebate depth 'E' of 6mm as standard. [other shank (C) and bearing sizes available].

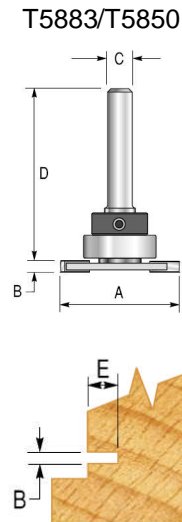

Ref No.	A	B	C	D	E
T5883	34mm	2mm	1/4"	45mm	6mm
T5850 - 1/2"	40mm	2.8mm	1/2"	82mm	6mm



FIRE, DRAUGHT, WEATHER & ACOUSTIC SEALS

Tel: 01329 221111 Fax: 01329 221122

Web: www.wis-ltd.com Email: sales@wis-ltd.com

ROUTER CUTTERS

Pile Carrier Cutter

Two flute bearing guided cutters for grooving to suit slide pile carriers from Exitex. The cutters are bearing guided and fitted with dust shields; the design of the cutter allows the groove to be positioned against the bottom of the rebate if required. The cutter is supplied with 1/2" shank and bearing to provide a rebate depth 'G' of 3mm as standard.

[other shank (C) and bearing sizes available].

We also supply a cutter (ref T5880) to suit the 7mm x 3mm self-adhesive pile carrier.

T5860 – OFFSET LEG

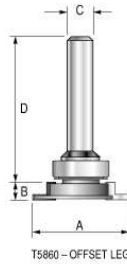

T5870 – CENTRE LEG

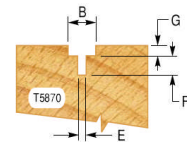
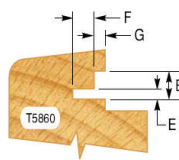
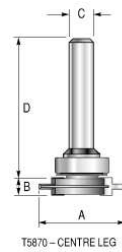

Ref No.	A	B	C	D	E	F
T5860 - 1/2"	46mm	7mm	1/2"	82mm	2mm	6mm
T5870 - 1/2"	46mm	7mm	1/2"	82mm	2mm	6mm
T5880 - 1/2"	32mm	7mm	1/2"	82mm	-	-

Intumescent Strip Groover

This two flute bearing guided cutter is designed for producing grooves for fitting intumescent strips. The cutter is supplied with 1/2" shank and bearing to provide a rebate depth 'G' of 4mm as standard.

[other shank (C) and bearing sizes available].

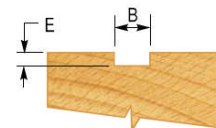
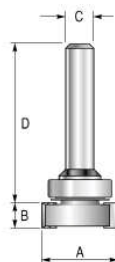

Ref No.	A	B	C	D	E
T5840 - 1/2"	36mm	10mm	1/2"	82mm	4mm
T5841 - 1/2"	36mm	15mm	1/2"	82mm	4mm
T5842 - 1/2"	36mm	20mm	1/2"	82mm	4mm